



Das Auto.

The Polo



Designed to impress. Built to last.

Striking design, uncompromising quality and exciting engines. That's what you can expect in the fabulous Polo, the tough little performer that's packed with big car credentials. Stylish, elegant and understated, the Polo is designed to stand the test of time, beautifully crafted inside and out, and testament to Volkswagen's lasting quality standards. Built for the long haul and designed to endure, the Polo is not just for now. It's for keeps.



Model shown is Polo SEL with optional 17" 'Boavista' alloy wheels.

Take time to admire your Polo. From every angle.

The Polo will certainly turn heads wherever it goes. But it's not just about looks. It's about performance, too. And with a choice of powerful engines, delivering impressive economy with high pulling power, there's one thing to look forward to above all else. The ultimate in driving fun.

* Please see the Engines section for fuel consumption and CO₂ emissions figures.



Model shown is Polo SEL with optional 17" 'Boavista' alloy wheels and metallic paint.

Explore the city.



Model shown is Polo SEL with optional 17" 'Boavista' alloy wheels, convenience pack and metallic paint.



Or discover the great outdoors.

Model shown is Polo SEL with optional 17" 'Boavista' alloy wheels.

Either way, you'll always feel at home.



Models shown are Polo SEL with optional 17" 'Boavista' alloy wheels and Polo Moda with optional 16" 'Navarre' alloy wheels and metallic paint.

Model shown is Polo SEL with optional 17" 'Boavista' alloy wheels and metallic paint.

Exterior

Dynamic, self assured, confident, the Polo exudes a sporty elegance designed to stand the test of time, rather than bow to fashion fads. Powerful lines accentuate its athletic character, while specific details, such as the stylish rear lights, define its classic style. A selection of individually designed alloy wheels gives you the opportunity to enhance the sporty feel, and contributes to the overall precision handling. This is a car you cannot help but notice, for all the right reasons.



The electrically heated and adjustable body-coloured door mirrors with integrated indicators enhance the streamlined bodyshape and help improve the aerodynamics. Standard on all models except S.



The striking rear lights blend perfectly with the rear design, highlighting its stylish contours.



Curved body-coloured door handles are not only easy-to-use, but flow seamlessly into the overall design, exuding quality and solidity. Standard on all models except S.



The front grille with attractive chrome trimmed radiator grille louvre is a distinctive characteristic of the Polo, contributing to its sporty elegance and adding a touch of quality and charisma. Standard on Moda, SE and SEL models.



Stylish halogen headlights blend seamlessly with the chrome trimmed radiator grille louvre, indicative of the Polo's uncompromising attention to detail. Providing better vision in all weather, they also include permanent running lights so that you can be seen easily during the day. Model shown is SE with optional Winter pack.



Rear tinted windows from the B pillar back reduce sunlight by up to 65%, helping to ensure a pleasant temperature for rear passengers, and enhancing the exterior's sporty appeal. Standard on Moda and optional on SEL and GTI models.

Enduring quality, leading performance.



Model shown is Polo SEL with optional 17" 'Boavista' alloy wheels.



Understated elegance and classic styling is present both inside and out in the **Polo S**, with high quality materials and attention to detail providing the perfect mix of style and comfort. Interior shown is Polo SA/C with stylish 'Cirrus' cloth upholstery.



The height-adjustable driver's and front passenger's seat can easily be adjusted to suit your optimum driving position, ensuring you reach your destination relaxed and in comfort.

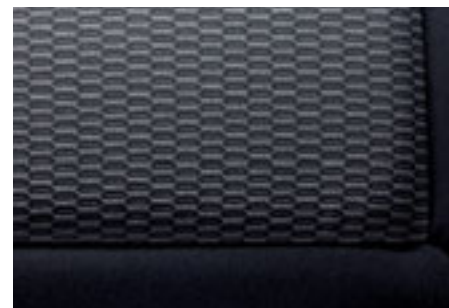

'Cirrus' upholstery features a sporty honeycomb design and is both robust and hard-wearing, its dark, easy-to-clean surface ensuring the fabric stays as new for a long time to come.

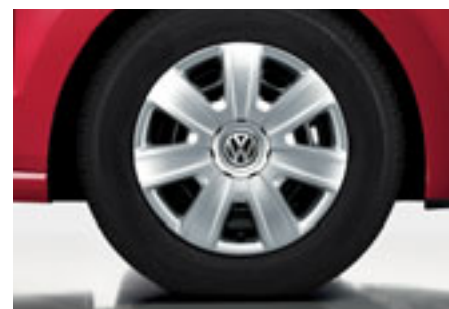

14 inch steel wheels with 175/70 R14 tyres and full size wheel trims, feature a robust seven spoke design, adding a sporty touch.

The Polo S

The entry level Polo S is packed with an extensive range of equipment, and provides a truly impressive package. For a start, body-coloured bumpers and side sills, halogen headlights and heat insulating green tinted glass provides an impressive exterior. Inside, 'Cirrus' upholstery and 'High Gloss Black' decorative inserts give an exclusive look, and features include electric front windows, central locking and speed-sensitive power-assisted steering. White instrument lighting, a three-spoke steering wheel and vanity mirrors complement the interior aesthetics, while front seats with height adjustment and RCD 210 radio/MP3 compatible CD player with four front speakers enhance your driving enjoyment. Other features include a folding rear seat backrest, heated rear windscreen with automatic switch-off, luggage compartment cover and lighting, storage compartment in the centre console and interior lighting with delay, providing practical extras to keep you comfortable. Specify the Polo SA/C and you get all the standard equipment of the S complete with 'Climatic' air conditioning with semi-automatic control for year round comfort.



The RCD 210 radio/MP3 compatible CD player will provide entertainment on every journey and has four front speakers to deliver excellent sound quality.



Choose the Polo SA/C and easy-to-use 'Climatic' semi-automatic air conditioning comes as standard, ensuring a pleasant temperature throughout the vehicle.



**The Polo BlueMotion.
Cleaner, greener and kinder to your wallet.**

Model shown is Polo BlueMotion with optional metallic paint.

The Polo BlueMotion

The Polo BlueMotion is a car that offers the highest levels of economy, exemplary environmental credentials and an aerodynamic body which is styled to turn heads. It has intelligently refined existing technology, and used a body-coloured styling pack, as well as dynamic lines and enhanced aerodynamics, to reduce the vehicle's air resistance. When combined with engineering refinements such as low rolling resistance tyres, this helps produce exceptional economy without compromising on comfort, safety or looks. Innovative technology such as the Start/Stop function momentarily switches off the engine when the vehicle is stationary, in neutral and the clutch disengaged. This is notified to the driver via the multifunction computer (Midline) which also displays a visual gear change recommendation for optimum fuel consumption. Battery regeneration is achieved by recuperating energy created during braking and deceleration, boosting the alternator voltage which in turn recharges the battery. During the acceleration phase it is possible to reduce the alternator load which improves economy. A combination of all these refinements delivers a package that offers outstanding economy up to 80.7 mpg over the Combined fuel cycle*. The 1.2 litre TDI 75 PS engine with DPF (Diesel Particulate Filter) also ensures CO₂ emissions are an impressively low 91 g/km. This places it in Vehicle Excise Duty band A, making the Polo BlueMotion exempt from the annual Road Fund Licence.

However, despite all the refinements to make the BlueMotion such an economical car, there really hasn't been any compromise on standard equipment. The BlueMotion builds over the already well equipped Polo S, yet is enhanced further with the choice of unique 'Blue Merlin' or 'Cirrus' cloth upholstery and 'Matt chrome' touches throughout the cabin. There is also an array of extra functionality to ensure your total comfort, such as 'Climatic' semi-automatic air conditioning, cruise control, electrically heated and adjustable door mirrors, front centre armrest, leather trimmed three spoke steering wheel and an RCD 310 radio/MP3 compatible CD player with six speakers and a clever AUX-in socket which allows you to connect your iPod or compatible MP3 player. We've not forgotten about your safety either, fitting remote central locking, a tyre pressure indicator and a tyre repair kit (in lieu of steel spare wheel) as standard. Externally the BlueMotion is distinguished by 15 inch 'Greenland' alloy wheels with 185/60 R15 low rolling resistance tyres, front fog lights, uniquely shaped bumpers, side skirts and spoiler and a unique front grille immediately distinguishable as a BlueMotion.

* Please see the Engines section for fuel consumption and CO₂ emissions figures.



The multifunction computer (Midline) provides useful statistics about your journey, such as exterior temperature, average and current fuel consumption, average speed and estimated distance to refuelling. It also includes a visual gear change recommendation for optimum fuel consumption.



The stylish interior of the Polo BlueMotion in Blue/Titan Black 'Blue Merlin' cloth upholstery features 'Matt chrome' touches to the air vents and gear lever gaiter surrounds, handbrake button and the internal door handles. There is also a choice of 'Cirrus' cloth upholstery for that extra touch of individuality. Interior shown is Polo BlueMotion with optional electronic climate control air conditioning and metallic paint.



The rear spoiler not only enhances the BlueMotion's dynamic lines but also helps to reduce the vehicle's air resistance, and in turn reduces fuel consumption.



The unique 'BlueMotion' badge at the rear symbolises its environmental credentials. For more information on BlueMotion Technologies, please see the Environment section.



'Greenland' 5 1/2 J x 15 light alloy wheels with 185/60 R15 low rolling resistance tyres help to reduce the BlueMotion's fuel consumption.



Dynamic, stylish and sporty, the **Polo Moda** has been designed to turn heads wherever it goes. A sporty exterior features stunning 15 inch 'Cadiz' six spoke alloy wheels, body-coloured door mirrors and door handles, a radiator grille with chrome trimmed louvre insert, front fog lights and rear tinted windows from the B pillar back.

The Polo Moda

Following on from the impressive specification of the S, the stylish aesthetics of the Moda continue with 'Matt chrome' detailing on the air vents, gear lever gaiter surround, internal door handles and handbrake button, while 'Strata' upholstery is both hard-wearing and comfortable. An RCD 310 radio/MP3 compatible CD player with six speakers provides exceptional acoustics, while a Multi Device Interface (MDI) offers USB and iPod connectivity. This allows you to play music from a compatible audio device through the radio speakers and track details will appear on the radio display. And if that's not enough to ensure total driving enjoyment, there are also front and rear electric windows (rear on five door models only), height adjustable driver and front passenger seats, easy entry sliding front seats (three door models only), a split folding rear seat backrest providing practical space, electrically heated and adjustable door mirrors, not to mention remote central locking, illuminated vanity mirrors front and rear reading lights. Specify the Polo Moda A/C and you get 'Climatic' air conditioning with semi-automatic control for even more comfort on every journey.



The RCD 310 radio/MP3 compatible CD player features six speakers and its large screen clearly displays radio station choices or the track listings of a compatible device connected to the **Multi Device Interface (MDI)**.



The **Multi Device Interface (MDI)** allows you to connect to an external multimedia source, such as USB or iPod, which you can operate via the vehicle's radio or optional navigation/radio system.



Front fog lights integrated into the front bumper are both attractive and stylish. They also provide better visibility in poor weather conditions.



'Cadiz' 6J x 15 alloy wheels with 195/55 R15 tyres and anti-theft wheel bolts add a particularly dynamic look, emphasising the Moda's sporty aesthetics.

The Polo SE

Take a seat in the Polo SE and you'll find an even higher level of specification, ensuring your total comfort. Building over the already well equipped S, stylish 15 inch seven spoke 'Castille' alloy wheels, body-coloured door mirrors and door handles, and a radiator grille with chrome trimmed louvre insert give a contemporary look to the exterior, echoed inside by attractive and extremely durable 'Strata' upholstery. Chrome detailing adds an extra touch of elegance and refinement, and can be found on the air vents, gear lever surround, handbrake button and internal door handles. A whole range of features helps ensure maximum driving pleasure, including 'Climatic' semi-automatic air conditioning, driver and passenger seat height adjustment and an RCD 310 radio/MP3 compatible CD player with six speakers and an AUX-in socket for connection to an external multimedia source (e.g. iPod and MP3 player), while useful details include remote central locking, electric front and rear windows (rear on five door models only), and electrically heated and adjustable door mirrors. You'll also find front and rear reading lights, illuminated vanity mirrors and a useful split folding rear seat backrest. Three door models also benefit from easy entry sliding and reclining seats to allow easy access for rear passengers.



The electrically heated and adjustable body-coloured door mirrors with integrated indicators enhance the exterior of the Polo and can be easily operated from the comfort of the driver's seat.



Sun visors incorporating an illuminated vanity mirror for both the driver and front passenger are a handy and practical feature.



Controls for the electric front and rear windows (rear on five door models only), including one-touch opening and closing facility, and the electrically heated and adjustable door mirror switch are conveniently located in the driver's door.

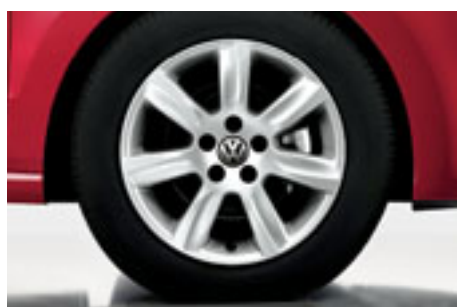

'Castille' 6J x 15 alloy wheels with 185/60 R15 tyres and anti-theft wheel bolts add a contemporary finishing touch to the exterior.



Easy-to-use 'Climatic' semi-automatic air conditioning ensures a pleasant temperature throughout the vehicle, so every journey will be a comfortable one whatever the temperature outside.



Subtle details such as the air vent surround, internal door handles, gear lever gaiter surround and handbrake button are highlighted in 'Matt chrome' to create unique interior styling. Interior shown is Polo SE in Titan Black 'Strata' cloth upholstery (also available in Seashell Beige) with optional front centre armrest, electronic climate control air conditioning, convenience pack and metallic paint.



Equipment and styling combine in harmony to produce an interior which exudes comfort and practicality, ensuring that every journey is a pleasurable experience. Interior shown is **Polo SEL** in Seashell Beige 'Strata' cloth upholstery (also available in Titan Black) with optional electronic climate control air conditioning and metallic paint.

The Polo SEL

If you want a car that goes one step further then the Polo SEL is the one for you. To start with, 16 inch 'Navarre' alloy wheels add a truly individual look to the exterior, enhanced by body-coloured door handles and door mirrors, front fog lights and a chrome trimmed radiator grille louvre and front air intake surround. Inside the Polo SEL, the luxury continues with a three-spoke leather trimmed steering wheel featuring a chrome insert, leather trimmed gear knob and handbrake grip and front footwell illumination. The RCD 310 radio/MP3 compatible CD player with six speakers offers great acoustics and there's also a Multi Device Interface (MDI) in the glovebox providing USB and iPod connectivity. The height adjustable driver and front passenger seats ensure comfort on long journeys with three door models benefiting from easy entry seats, while the multifunction computer (Midline) is a particularly useful addition, providing essential information as you drive, such as instant and average fuel consumption, fuel range, exterior temperature and clock. 'Climatic' semi-automatic air conditioning ensures an ambient temperature throughout and a handy tyre pressure indicator displays any loss in tyre pressure. Completing the picture is an alarm with interior protection, a front centre armrest with storage compartment, drawers under the front seats and high quality carpet mats in the front and rear.



The Polo's centre console houses the RCD 310 radio/MP3 compatible CD player, keeps all important functions within easy reach, and is testament to Volkswagen's passion for build quality, ergonomic design, safety and passenger comfort.



'Navarre' 7J x 16 alloy wheels with 215/45 R16 tyres and anti-theft wheel bolts complements the overall design of the Polo SEL perfectly, adding a truly individual touch.

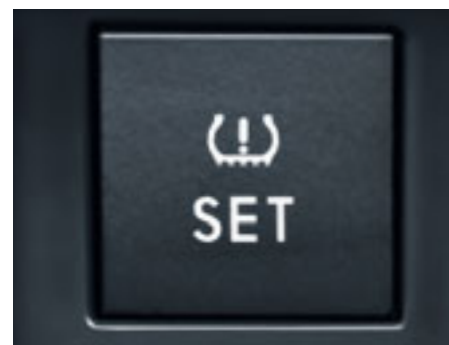

In the event of a change in air pressure, the tyre pressure indicator alerts the driver via a warning in the multifunction display. Not only does correct tyre pressure ensure a high degree of safety, but it also helps extend the life of the tyres and reduces fuel consumption.



The Multi Device Interface (MDI) connects you to external audio sources, such as USB or iPod, which you can operate via the radio or optional navigation/radio system.



The multifunction computer (Midline) displays current fuel consumption figures on the monitor screen, and also makes recommendations for optimal gear changes on the 1.4 litre 85 PS and diesel models.

The new Polo GTI.
Dynamic, stylish and the most exhilarating Polo to date.



Model shown is new Polo GTI with optional rear tinted windows.

The new Polo GTI

The new Polo GTI is a real, heart thumping experience, with its sleek lines, aggressive look and phenomenal performance it really is the ultimate Polo. It commands many an envious glance with its iconic GTI honeycomb grille and red radiator grille louvres, which are instantly recognisable wherever you go. Uniquely shaped front and rear bumpers and extended black side sills combine with the 15 mm lowered sports suspension to give the GTI its sporty stance, with sparkling 17 inch 'Monza' alloy wheels and red brake calipers continuing the distinctly GTI look. At the rear the distinctive chrome twin exhaust tailpipe announce the impressive performance under the bonnet, with a body-coloured rear spoiler enhancing its dynamic silhouette. Lastly, front fog lights offer better visibility, while the GTI badging at the front and rear are the final touch, all making the new Polo GTI the most stylish and dynamic Polo we've ever built.

The highlight of the new Polo GTI has got to be its phenomenal performance. The 1.4 litre TSI twincharged engine produces an incredible 180 PS via direct injection and the dual charging of a turbocharger and a supercharger. Coupled with a seven speed DSG dual clutch gearbox, it allows you to change gear into the next pre-selected gear almost imperceptibly, without losing power or traction. Producing 250 Nm of torque and using XDS electronic differential lock for the first time in a Polo to improve traction and handling, it really does produce a thrilling and engaging drive worthy of the iconic GTI name.



The front of the new Polo GTI is more stylish than ever, featuring its renowned black honeycomb grille, traditional red louvres and gleaming chrome GTI badge. The honeycomb structure is echoed in the front air intake, while the body-coloured front spoiler completes the impressive front design.



Standard 7 1/2 J x 17 'Monza' alloy wheels with 215/40 R17 low profile tyres give the new Polo GTI its purposeful image, the distinctive five spoke design revealing the red brake calipers behind.



The unique leather trimmed three spoke steering wheel, gear knob and handbrake grip feature exclusive red stitching, adding an air of exclusivity to the interior.



The front fog lights of the new Polo GTI are neatly integrated into the lower front bumper. Not only do they improve safety in the event of poor visibility, but they also provide a sporty finish.



Step inside and you'll notice that the interior of the new Polo GTI makes no compromises either. The height adjustable front sports seats are upholstered in classic GTI 'Jacara' cloth with the GTI logo proudly embroidered into the backrest, while the pronounced side bolsters offer optimum lateral support. The flat bottomed sports steering wheel includes paddle shift for quick and easy gear changes, while the red stitching and a 'GTI' logo insert add an extra sporty feel. This is complemented perfectly by 'GTI' style decorative inserts in the dash and centre console, front and rear carpet mats with red stitching, door sill strips with GTI logo, black rooflining and aluminium-look pedals. Even the gear knob has red stitching and a unique design, so as soon as you get in, you know you're in a GTI. Interior shown is new Polo GTI featuring optional electronic climate control air conditioning and convenience pack.

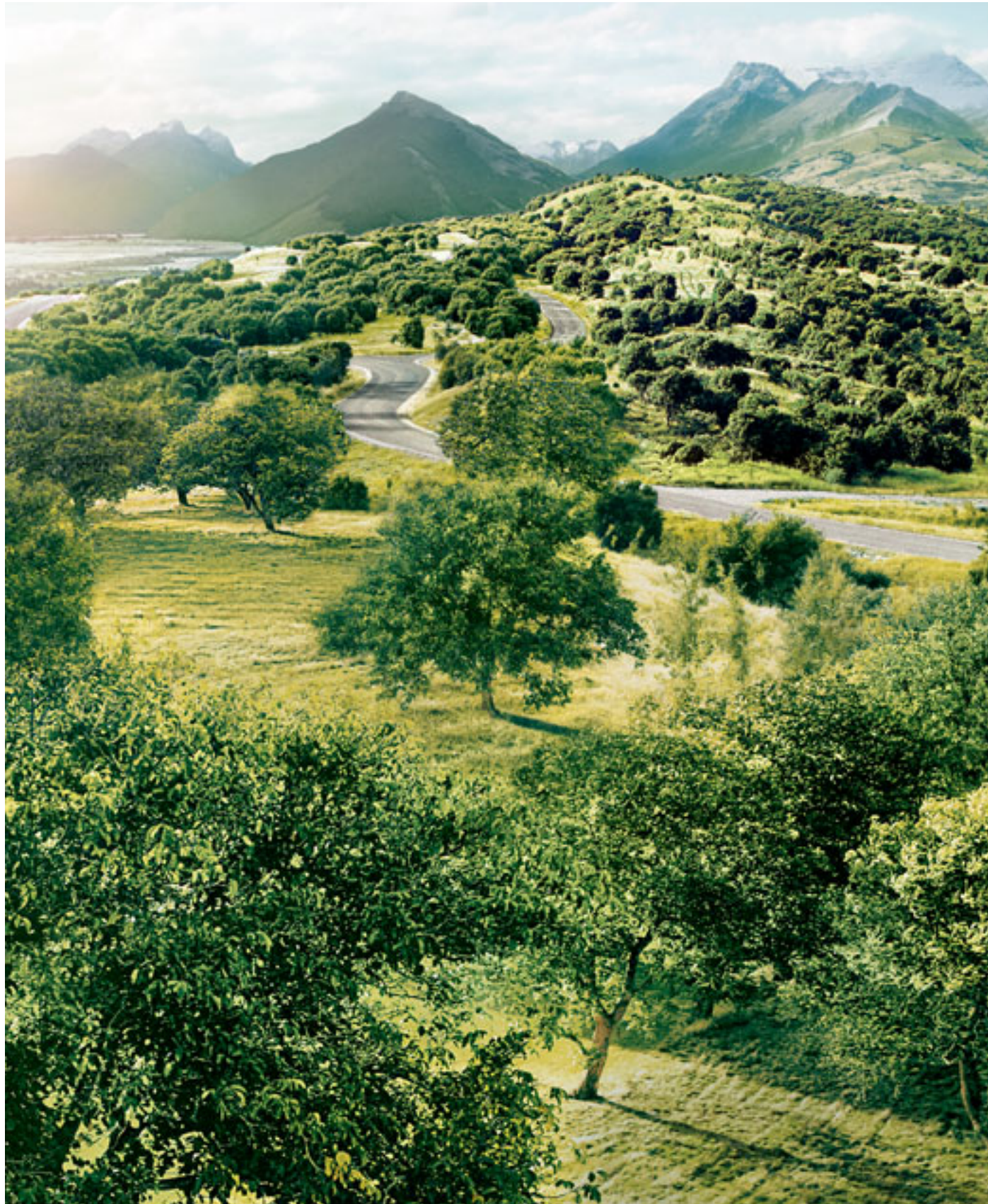

To help reduce the impact on our environment, not only have we come up with a solution, we've designed many.

BlueMotion Technologies is our contribution to sustainable motoring. This means we offer optimum solutions for every demand, which makes driving more fuel efficient. Lower fuel consumption and lower emission diesel engines allied with BlueMotion Technologies are friendlier to the environment and your wallet, without having to give up everyday practicality and comfort.

The Polo has been setting benchmarks for years and with the Polo BlueMotion we've set another one; the most efficient and eco-sensitive Polo we've ever built. Our engineers have strived to produce a cleaner, more efficient Polo that still offers great performance and handling. The result of their work is an impressive range of refinements and innovations that save fuel and cut CO₂ emissions. Its dynamic bodykit and front grille reduce the vehicle's air resistance and, combined engineering refinements, such as longer gear ratios to reduce revs and low rolling resistance tyres, all improve fuel consumption and help produce exceptional economy. We've also designed a range of other energy-saving technologies to work in synergy with our advanced engines and gearboxes. BlueMotion Technologies such as a multifunction computer including visual gear change recommendation for optimum fuel consumption, recuperation (battery regeneration during braking) and a Start/Stop function that can cleverly switch the engine off when your vehicle is stationary and in neutral and start it again as you depress the clutch, all combine to aid increased efficiency. A combination of all these refinements means the 1.2 litre TDI 75 PS engine delivers a package that offers outstanding economy and high performance, achieving an impressive 80.7 mpg on the Combined fuel cycle*. With a DPF (Diesel Particulate Filter) fitted as standard, it also ensures CO₂ emissions are from an impressively low 91 g/km, making it exempt from VED (Vehicle Excise Duty).

Externally, Volkswagen's 'BlueMotion' badging identifies the cleanest, most energy-efficient cars in our range. So when you see these logos you'll know we're talking about ways to cut emissions and the cost of your motoring. Environmental technologies of today are meeting the driving challenges of tomorrow with one very important aim: to reduce the impact of our cars on the environment for future generations.

* Please see the Engines section for fuel consumption and CO₂ emissions figures.

BLUEMOTION
— TECHNOLOGIES —

Sometimes you just have to stop and admire the view.



Model shown is Polo SEL with optional 17" 'Boavista' alloy wheels.

Safety

The Polo not only delivers new levels of driving fun, but also, a wealth of advanced safety equipment, helping to make every journey as safe as possible. Features include a sophisticated airbag system, comprising of driver's and front passenger's airbags and side head/thorax airbag system which provide occupant protection. Add to that an Anti-lock Braking System (ABS) with Hydraulic Brake Assist (HBA) and an Electronic Stabilisation Programme (ESP) which recognises critical driving situations and reacts in milliseconds by braking individual wheels and reducing the engine's output to bring the vehicle under control. Also, for the first time, the new Polo GTI features XDS, an extension of the well-known Electronic Differential Lock (EDL) function. This is linked to the Electronic Stabilisation Programme (ESP) hydraulics and works by applying pressure to the inner front wheel during fast cornering to prevent wheel-spin. The one-sided, precise brake pressure helps to maximise traction, reduce understeer and improve responses, thus making cornering even more sporty, safe and accurate. Front whiplash-optimised head restraints, three rear head restraints, warning buzzer and light for seat belts if unfastened and Isofix child seat preparation provide additional all-round safety. Such a high level of protection means you've nothing else to think about except sitting back, relaxing and enjoying the drive.



The two **whiplash-optimised front head restraints** not only ensure additional comfort, but also provide particularly effective support for the head and spine in the event of a collision.



Part of the optional **Sensor pack, rear parking sensors** emit acoustic signals, alerting you to obstacles in your way when parking: The closer you are to an object, the faster the sound frequency. They also offer a visual display of the vehicle's proximity to obstacles on your radio display.

Optional on all models except S.



In an emergency situation, all passengers can rely on the safety of the Polo, which includes **driver's and front passenger's seat airbags as well as a side head/thorax airbag system**. Deployment of the airbags is activated by crash sensors. When an impact is registered, the airbag control unit ignites the gas generator, which then inflates the airbag within less than 40 milliseconds, helping to reduce injuries significantly. Also available as an option is a curtain airbag system for front and rear seat passengers and front passenger's airbag deactivation, should you require it.

Curtain airbag system and front passenger's airbag deactivation are optional on all models. Specify the curtain airbag system, and conventional side impact airbags are fitted in the driver's and front passenger's seats, in lieu of the side head/thorax airbag system. Image shown is for illustration purposes only and may not necessarily reflect UK specification.



The **Electronic Stabilisation Programme (ESP)** recognises critical driving situations and reacts in milliseconds by targeting brake and management systems, controlling the speed of individual wheels and helping to bring the vehicle under control. As a result the vehicle achieves maximum directional stability.



A **high level third brake light** integrated into the rear spoiler enhances aesthetics and improves vehicle safety.

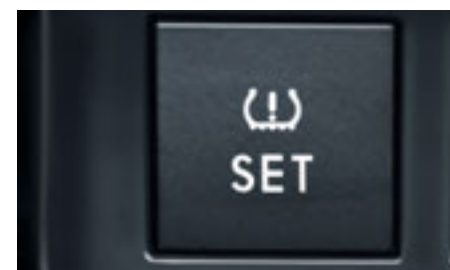

As part of the **Sensor pack, the tyre pressure indicator** will alert you to any change in tyre pressure via a warning in the multifunction display, advising you to rectify the situation.

Standard on SEL and GTI models and optional as part of the Sensor pack on Moda and SE models.



Front fog lights add a striking look to the front of the vehicle and provide safety in bad weather or where there is poor visibility. Available in conjunction with front fog lights, is the **static cornering function**, which illuminates when indicating or turning at low speed, providing additional safety.

Front fog lights are standard on BlueMotion, Moda, SEL and GTI and optional on SE models. Static cornering function is optional on BlueMotion, Moda, SEL and GTI models.

Let the adventure begin.



Model shown is Polo SEL with optional metallic paint.



Model shown is Polo SEL with optional 17" 'Boavista' alloy wheels.

Optional equipment

Once you're on the road, you'll find it's the extra details that add a new dimension to your journey. Whether you're looking for a state-of-the-art music system or perfect air conditioning for your passengers, a number of options are available, enabling you to equip your Polo to your individual needs.



The **multifunction leather trimmed steering wheel** is exceptionally user friendly and enables you to operate the radio without taking your hands off the wheel. The handbrake grip and gear knob are also leather trimmed, adding a touch of elegance and refinement to the interior, and providing particularly good grip when driving. Also included with this option on Moda and SE models is a multifunction computer (Midline) which provides important information about your journey. Optional on all models except S.

Interior shown is SE with optional multifunction leather trimmed steering wheel and electronic climate control air conditioning.



Optional **Alcantara sports seats** add a luxurious, sporty look to the interior. Soft and supple, yet hard-wearing and durable, its finish provides the ultimate in comfort and practicality, combining with the seat design to give exceptional lateral support, while ensuring total relaxation on long journeys. Optional on SEL models.

Interior shown is SEL.



The **multifunction computer (Midline)** provides essential information about your journey, such as current and average fuel consumption, average speed, distance travelled, exterior temperature and total mileage. On the 1.4 litre 85 PS and all diesel models an additional feature provides a visual gear change recommendation for optimum fuel consumption. Standard on BlueMotion, SEL and GTI models. The multifunction computer (Midline) is available as part of the optional Sensor pack on Moda and SE models, or in conjunction with the optional multifunction leather trimmed steering wheel on Moda and SE models.

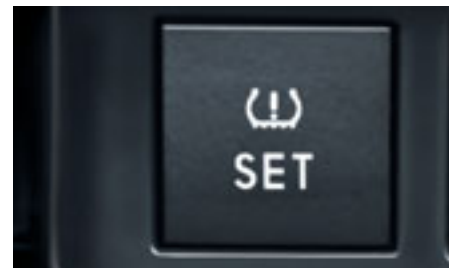

Forming part of the **Sensor pack**, the **tyre pressure indicator** will alert you to any change in tyre pressure via a warning in the multifunction display, advising you to rectify the situation. At speeds of over 19 mph, **cruise control** keeps your selected speed constant, enabling you to relax on longer journeys, without having to keep an eye on your speedometer. **Rear parking sensors** emit acoustic signals, alerting you to obstacles in your way when parking. The closer you are to an object, the faster the sound frequency. They also offer a visual display of the vehicle's proximity to obstacles on the screen of the radio system. Optional on Moda, SE, SEL and GTI models.

Tyre pressure indicator is standard on BlueMotion, SEL and GTI models, cruise control is standard on BlueMotion models.



The RCD 510 touch-screen radio/dash-mounted MP3 compatible six CD autochanger features a large 6½ inch colour display, with intuitive menu navigation and touch-screen operation. It also features an AUX-in socket for connection to an external multimedia source (e.g. iPod or MP3 player) and an SD memory card slot. Optional on all models except S.

RCD 310 radio system, RCD 510 radio system and RNS 310 navigation/radio system cannot be specified in conjunction with each other.



The RNS 310 touch-screen navigation/radio system features a 5 inch colour display for clear map navigation, guiding you to your destination using all but the last two digits of a UK postcode. The MP3 compatible single CD player will play music CDs even when the navigation system is being used, while music can also be played via the SD card slot. Optional on all models except S.

RNS 310 touch-screen navigation/radio system and DAB digital radio receiver cannot be specified in conjunction with each other.



The RCD 310 radio/MP3 compatible CD player features six speakers with an output of 4 x 20 watts. It also features an AUX-in socket for connection to an external multimedia source (e.g. iPod or MP3 player). Optional on S models. The RCD 310 can also be specified with **Multi Device Interface (MDI)** with iPod and USB cables enabling you to connect and charge a compatible device, while track selection is viewed and selected via the RCD 310's audio display. Optional on S models. The **Multi Device Interface (MDI)** is also available as an option on BlueMotion and SE models.

RCD 310 radio/MP3 compatible CD player is standard on all models except S. Multi Device Interface (MDI) is standard on Moda, SEL and GTI models. RCD 310 radio system, RCD 510 radio system and RNS 310 navigation/radio system cannot be specified in conjunction with each other.

Also available, but not shown:

The **DAB digital radio receiver** is available as an upgrade for your RCD 310 or RCD 510, enabling you to listen to all the digital stations available in crystal digital sound. Optional on all models except S.

DAB digital radio receiver and RNS 310 touch-screen navigation/radio system cannot be specified in conjunction with each other.



The **electronic climate control air conditioning system** is extremely user-friendly, providing your required cabin temperature quickly and efficiently, while maintaining your selected temperature. Optional on SA/C, BlueMotion, Moda A/C, SE, SEL and GTI models.



Headlight washers form part of the **Winter pack**, helping to improve safety in rain, snow and poor road conditions. Heated front seats provide comfort during cold weather, while heated windscreen washer jets help ensure visibility is maintained in the winter months. A low washer fluid warning light is also included. Optional on all models.

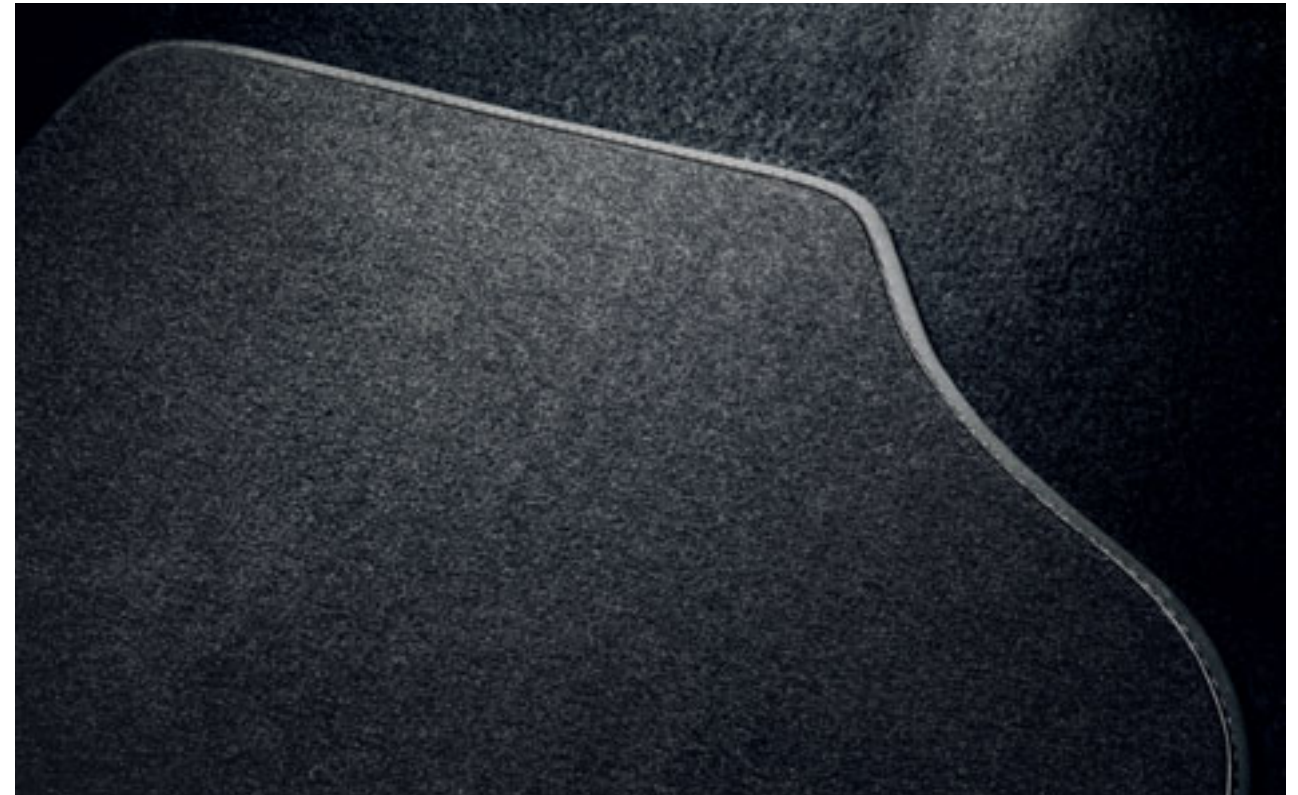

Luxurious and durable **carpet mats for the front and rear** are a welcome addition to the Polo, helping to keep the interior looking its best. Optional on all models and standard on SEL and GTI models. On GTI models the carpet mats feature distinctive red stitching.



Heated front seats, which form part of the **Winter pack**, greatly increase comfort levels, especially in winter, providing heat faster than the car's heating system. Optional on all models.



The **convenience pack** comprises an automatically dimming interior rear-view mirror which darkens when a following car's headlights are too high, and rain sensor, which automatically activates and controls the windscreen wipers when it detects moisture on the windscreen. Optional on all models except S.

Wheels

Add a touch of style and personality with this great choice of wheels and tyres. Alloys add a distinctively sporty look to your car, carefully chosen to enhance the exterior styling of every model. These alloy wheel options give you plenty of opportunity to express your individuality and transform the appearance of your Polo. As well as the styling, they also offer sporting performance which is all about feeling the road beneath the wheels while staying in control, enabling you to maintain the perfect balance between power and dynamics in any situation.



'Boavista' 7J x 17 inch alloy wheels with 215/40 R17 tyres and are eye-catching and stylish, and are fitted with anti-theft wheel bolts. Optional on SEL models.



14 inch steel wheels with 175/70 R14 tyres and full size wheel trims feature a robust seven spoke design, adding a sporty touch. Standard on S models.



'Greenland' 5½J x 15 light alloy wheels with 185/60 R15 low rolling resistance tyres help to reduce the BlueMotion's fuel consumption. Standard on BlueMotion models.



'Cadiz' 6J x 15 alloy wheels with 195/55 R15 tyres and anti-theft wheel bolts add a particularly dynamic look, emphasising the Polo's sporty aesthetics. Standard on Moda and optional on S models.



'Castille' 6J x 15 alloy wheels with 185/60 R15 tyres and anti-theft wheel bolts add a contemporary finishing touch to the exterior. Standard on SE models.



'Navarre' 7J x 16 alloy wheels with 215/45 R16 tyres and anti-theft wheel bolts complements the overall design of the Polo perfectly, adding a truly individual touch. Standard on SEL and optional on Moda and SE models.



'Monza' 7½J x 17 alloy wheels with 215/40 R17 low profile tyres and anti-theft wheel bolts give the GTI a sporty intent, while the red brake calipers help to create an even more stylish exterior. Standard on GTI models.



**You'll just want to keep on driving,
late into the night.**

Model shown is Polo SEL with optional 17" 'Boavista' alloy wheels.

Paint

	<p>Glacier Blue Metallic 3N</p> <p>BM</p>
	<p>Black Non-Metallic A1</p> <p>P BM GTI</p>
	<p>Sunset Orange Metallic 4S</p> <p>P</p>
	<p>Candy White Non-Metallic B4</p> <p>P BM GTI</p>
	<p>Reflex Silver Metallic 8E</p> <p>P BM GTI</p>
	<p>Flash Red Non-Metallic D8</p> <p>P GTI</p>
	<p>Shadow Blue Metallic P6</p> <p>P BM GTI</p>
	<p>Sea Blue Non-Metallic F4</p> <p>P</p>
	<p>Nimbus Grey Metallic U5</p> <p>P</p>
	<p>Savanah Yellow Non-Metallic H5</p> <p>P</p>
	<p>Deep Black Pearl Effect 2T</p> <p>P GTI</p>

P S, Moda, SE, SEL **BM** BlueMotion **GTI** GTI

Standard Optional at extra cost

Please note: Screen technology does not allow for exact reproduction of the paint colours.

Upholstery

Titan Black
 'Cirrus' cloth †
 BY

Standard on S, S A/C and BlueMotion



Blue/Titan Black
 'Blue Merlin' cloth †
 RY

Standard on BlueMotion



Titan Black
 'Strata' cloth
 HX

Standard on Moda, Moda A/C, SE and SEL

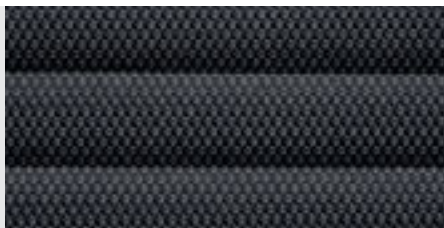

Seashell Beige
 'Strata' cloth
 HY

Standard on Moda, Moda A/C, SE and SEL



Black/Red
 'Jacara' cloth
 XE

Standard on GTI



Titan Black
 'Alcantara' sports seats with 'Microfibre' side bolsters
 DM

Optional on SEL



■ Standard ■ Optional at extra cost

† Please note, a choice of either 'Cirrus' or 'Blue Merlin' cloth is available on BlueMotion models.
 Please note: Screen technology does not allow for exact reproduction of the upholstery colours.

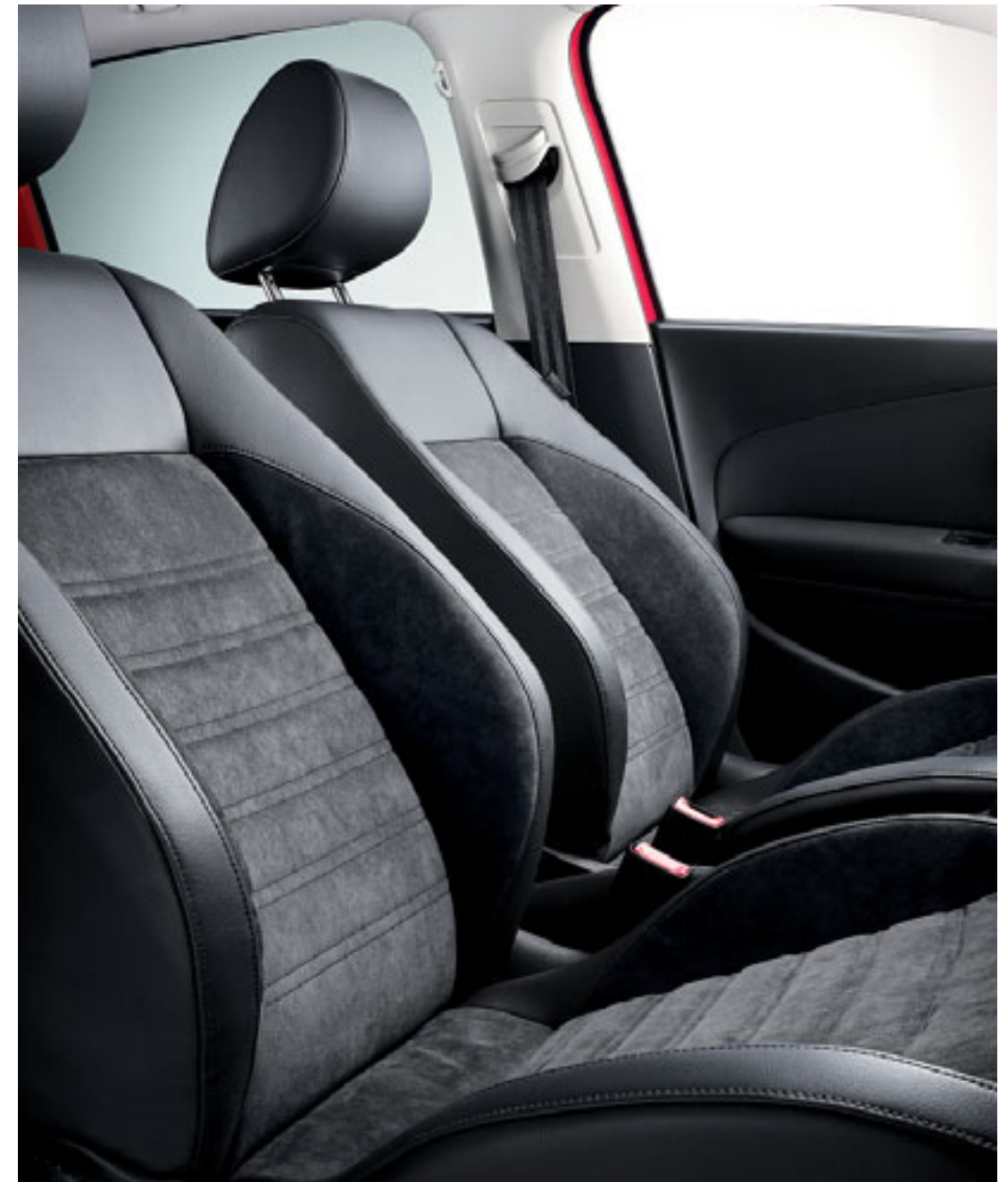

Optional 'Alcantara' sports seats add a luxurious, sporty look to the interior.

Interior shown is SEL.

Combinations

	Seat upholstery	Carpet	Dashboard	Black (A1) *	Candy White (B4)	Flash Red (D8)	Sea Blue (F4)	Savanah Yellow (H5) *	Glacier Blue Metallic (3N) *	Sunset Orange Metallic (4S) *	Reflex Silver Metallic (8E) *	Shadow Blue Metallic (P6) *	Nimbus Grey Metallic (U5) *	Deep Black Pearl Effect (2T) *
'Cirrus' cloth Standard on S and SA/C	Titan Black (BY)	Black	Black/Black	●	●	●	●	●	-	●	●	●	●	●
'Cirrus' cloth † Standard on BlueMotion	Titan Black (BY)	Black	Black/Black	●	●	-	-	-	●	-	●	●	-	-
'Blue Merlin' cloth † Standard on BlueMotion	Blue/Titan Black (RY)	Black	Black/Black	●	●	-	-	-	●	-	●	●	-	-
'Strata' cloth Standard on Moda, Moda A/C, SE and SEL	Titan Black (HX)	Black	Black/Black	●	●	●	●	●	-	●	●	●	●	●
	Seashell Beige (HY)	Black	Black/Black	●	●	-	●	-	-	-	●	●	●	●
'Jacara' cloth Standard on GTI	Black/Red (XE)		Black/Black/Black	●	●	●	-	-	-	-	●	●	-	●
'Alcantara' sports seats with 'Microfibre' side bolsters* Optional on SEL	Titan Black (DM)	Black	Black/Black	○	○	○	○	○	-	○	○	○	○	○

* Black (A1), Savanah Yellow (H5), metallic and pearl effect paints and Alcantara upholstery are optional at extra cost.
† Please note, a choice of either 'Cirrus' or 'Blue Merlin' cloth is available on BlueMotion models.

● Standard.
○ Optional at extra cost.
- Not available.

Refined engineering.



Model shown is Polo SEL with optional 17" 'Boavista' alloy wheels and convenience pack.



Model shown is Polo SEL with optional 17" 'Boavista' alloy wheels.

Engines and gearboxes

A selection of powerful engine variants means you can enjoy exceptional performance, impressive pulling power and smooth handling alongside frugal fuel consumption. The Polo offers a choice of petrol and diesel engines, all designed to deliver dynamic performance, impressive fuel economy and lower emissions. The range starts with three 1.2 litre petrol units which develop 60 PS, 70 PS and 105 PS. The 60 PS and 70 PS engines are both capable of achieving 51.4 mpg over the Combined fuel cycle*. The 105 PS version accelerates from standstill to 62 mph in just 9.7 seconds, whilst still returning 53.3 mpg on the Combined fuel cycle*. A 1.4 litre unit, is also available with a seven speed auto DSG gearbox developing 85 PS and capable of 48.7 mpg over the Combined fuel cycle*. And finally, if it's a real sports performer you're after, then look no further than the 1.4 litre 180 PS which powers the new Polo GTI. Delivering excellent performance and torque, it accelerates the GTI to 62 mph in just 6.9 seconds on its way to a top speed of 142 mph, where the law permits, while still returning 47.9 mpg on the Combined fuel cycle*. If it's a diesel you desire, two diesel engines featuring common rail technology are sure to be to your liking. The 1.2 litre 75 PS is sure to please with a CO₂ figure of 102, and an impressive 72.4 mpg on the Combined fuel cycle*, while the 1.6 litre unit which develops 90 PS, has a CO₂ of 112 an equally impressive 65.7 mpg on the Combined fuel cycle*. Finally, a diesel engine is available on BlueMotion models offering CO₂ emissions of just 91 g/km while achieving up to 80.7 mpg on the Combined fuel cycle*, making it the most economical engine available in a Volkswagen today. Kinder to your pocket and the environment, what better way to enjoy your Polo?



The dual-clutch Direct Shift Gearbox (DSG) represents a milestone in the development of the latest gearbox technology. This innovative automatic gearbox from Volkswagen shifts smoothly and imperceptibly, within a hundredth of a second, into the pre-selected next gear, without disrupting the power. Such extremely short reaction times and direct response behaviour make sporty acceleration even more fun. The seven speed gearbox is not only highly dynamic, but also extremely fuel-efficient.



The **manual gearbox** transmits power with short, accurate shifts and very smooth handling, making it easy-to-use at the right engine speed.



Featuring Volkswagen's latest **common rail** technology, the Polo's diesel engines ensure excellent overall performance, fuel consumption and CO₂ emissions. As part of Volkswagen's continued desire to satisfy European emissions legislation, the Polo's diesel engines are also fitted with a **Diesel Particulate Filter (DPF)** as standard. This is part of the exhaust system responsible for cleaning the exhaust gases before they enter the atmosphere. In addition to converting the harmful exhaust gases in the same way as a conventional catalytic converter, the DPF uses advanced technology to reduce the emission of black smoke and soot. It filters the exhaust gases and particles before they leave the vehicle exhaust system, resulting in a cleaner environment and less pollution entering the atmosphere.

S, S A/C, Moda, Moda A/C, SE – 1.2 litre 60 PS

Technical specification

		Manual		Notes
Engine	Engine type	Three cylinder petrol		<p>01) The maximum power output figures are quoted in PS (or Pferdestärke, which is the metric equivalent of horsepower). To convert from metric to imperial horsepower, divide the PS figure by 1.0139.</p> <p>02) Figures are calculated in accordance with manufacturer's criteria. The individual unladen weight depends on the specification of the vehicle, this then reduces the possible payload accordingly. The unladen weight and payload both include the fuel tank 90% full, driver (68 kg) and luggage (7 kg) in line with EU directive 95/48. Unladen weight shown refers to 3-door models. The unladen weight of 5-door models will increase by 25 kg.</p> <p>03) With increasing altitude the engine performance diminishes. From 1,000 m above sea level and for every 1,000 m thereafter 10% of the vehicle/trailer weight (trailer weight + gross vehicle weight) must be deducted.</p> <p>04) Thanks to the knock control, unleaded four star (at least 95 RON) can be used instead of unleaded Super plus. In order to achieve maximum fuel consumption benefits on the TSI engine, Ultra Low Sulphur Petrol (ULSP) must be used.</p> <p>05) The use of RME and FAME (bio diesel) is not possible.</p> <p>06) Official fuel consumption according to EU Directive 99/94. The consumption calculation according to 1999/100/EC is based on the actual unladen weight of the vehicle. Additional specifications can lead to a higher weight class and hence to consumption figures of this higher weight class. The driving style, road and traffic conditions, environmental influences and vehicle condition can in practice lead to consumption figures, which may differ from those calculated with this standard.</p> <p>07) The weight of a vehicle will influence the level of CO₂ emission it produces; as a result, vehicles with higher levels of specification and factory-fitted options may emit higher levels of CO₂.</p>
	Cubic capacity, ltrs/cc	1.2/1198		
	Max. output, PS ⁽⁰¹⁾ /kW at rpm	60/44 5200		
	Max. torque, lbs.ft/Nm at rpm	80/108 3000		
	Gearbox	Five speed manual		
Weights, kgs	Unladen weight ⁽⁰²⁾	1067		
	Gross vehicle weight	1550		
	Payload ⁽⁰²⁾	558		
	Axle load limit: Front Rear	830 770		
Trailer load limits, kgs⁽⁰³⁾	Braked 12% incline	800		
	Unbraked	520		
	Towbar load limit	50		
	Max. roof load	75		
Performance	Top speed (where the law permits), mph (km/h)	98 (157)		
	Acceleration, secs 0 - 62 mph	16.1		
	ABI insurance group, 1 - 20 (1 - 50) [†]	2E (4E)		
Environmental information	Fuel grade, minimum	Unleaded, 95 RON ⁽⁰⁴⁾		
	Fuel tank capacity, galls/ltrs	10.0/45		
	Official fuel consumption, mpg/ltr per 100 km ⁽⁰⁶⁾			
	Urban	38.7/7.3		
	Extra-urban	62.8/4.5		
	Combined	51.4/5.5		
	Official CO ₂ emission, g/km ⁽⁰⁷⁾	128		
Emission class	EURO 5			
Noise, dB	73.0			

† Please note, as of December 2009 the insurance industry switched from the current rating system of groups 1 - 20 to a new 1 - 50 insurance scale.

S, S A/C, Moda, Moda A/C, SE – 1.2 litre 70 PS

Technical specification

		Manual		Notes
Engine	Engine type	Three cylinder petrol		<p>01) The maximum power output figures are quoted in PS (or Pferdestärke, which is the metric equivalent of horsepower). To convert from metric to imperial horsepower, divide the PS figure by 1.0139.</p> <p>02) Figures are calculated in accordance with manufacturer's criteria. The individual unladen weight depends on the specification of the vehicle, this then reduces the possible payload accordingly. The unladen weight and payload both include the fuel tank 90% full, driver (68 kg) and luggage (7 kg) in line with EU directive 95/48. Unladen weight shown refers to 3-door models. The unladen weight of 5-door models will increase by 25 kg.</p> <p>03) With increasing altitude the engine performance diminishes. From 1,000 m above sea level and for every 1,000 m thereafter 10% of the vehicle/trailer weight (trailer weight + gross vehicle weight) must be deducted.</p> <p>04) Thanks to the knock control, unleaded four star (at least 95 RON) can be used instead of unleaded Super plus. In order to achieve maximum fuel consumption benefits on the TSI engine, Ultra Low Sulphur Petrol (ULSP) must be used.</p> <p>05) The use of RME and FAME (bio diesel) is not possible.</p> <p>06) Official fuel consumption according to EU Directive 99/94. The consumption calculation according to 1999/100/EC is based on the actual unladen weight of the vehicle. Additional specifications can lead to a higher weight class and hence to consumption figures of this higher weight class. The driving style, road and traffic conditions, environmental influences and vehicle condition can in practice lead to consumption figures, which may differ from those calculated with this standard.</p> <p>07) The weight of a vehicle will influence the level of CO₂ emission it produces; as a result, vehicles with higher levels of specification and factory-fitted options may emit higher levels of CO₂.</p>
	Cubic capacity, ltrs/cc	1.2/1198		
	Max. output, PS ⁽⁰¹⁾ /kW at rpm	70/51 5400		
	Max. torque, lbs.ft/Nm at rpm	83/112 3000		
	Gearbox	Five speed manual		
Weights, kgs	Unladen weight ⁽⁰²⁾	1067		
	Gross vehicle weight	1550		
	Payload ⁽⁰²⁾	558		
	Axle load limit: Front Rear	830 770		
Trailer load limits, kgs⁽⁰³⁾	Braked 12% incline	800		
	Unbraked	530		
	Towbar load limit	50		
	Max. roof load	75		
Performance	Top speed (where the law permits), mph (km/h)	103 (165)		
	Acceleration, secs 0 - 62 mph	14.1		
	ABI insurance group, 1 - 20 (1 - 50) [†]	3E (5E)		
Environmental information	Fuel grade, minimum	Unleaded, 95 RON ⁽⁰⁴⁾		
	Fuel tank capacity, galls/ltrs	10.0/45		
	Official fuel consumption, mpg/ltr per 100 km ⁽⁰⁶⁾			
	Urban	38.7/7.3		
	Extra-urban	62.8/4.5		
	Combined	51.4/5.5		
	Official CO ₂ emission, g/km ⁽⁰⁷⁾	128		
Emission class	EURO 5			
Noise, dB	73.0			

† Please note, as of December 2009 the insurance industry switched from the current rating system of groups 1 - 20 to a new 1 - 50 insurance scale.

SE, SEL – 1.4 litre 85 PS

Technical specification

		Manual	Automatic DSG	Notes
Engine	Engine type	Four cylinder petrol	Four cylinder petrol	<p>01) The maximum power output figures are quoted in PS (or Pferdestärke, which is the metric equivalent of horsepower). To convert from metric to imperial horsepower, divide the PS figure by 1.0139.</p> <p>02) Figures are calculated in accordance with manufacturer's criteria. The individual unladen weight depends on the specification of the vehicle, this then reduces the possible payload accordingly. The unladen weight and payload both include the fuel tank 90% full, driver (68 kg) and luggage (7 kg) in line with EU directive 95/48. Unladen weight shown refers to 3-door models. The unladen weight of 5-door models will increase by 25 kg.</p> <p>03) With increasing altitude the engine performance diminishes. From 1,000 m above sea level and for every 1,000 m thereafter 10% of the vehicle/trailer weight (trailer weight + gross vehicle weight) must be deducted.</p> <p>04) Thanks to the knock control, unleaded four star (at least 95 RON) can be used instead of unleaded Super plus. In order to achieve maximum fuel consumption benefits on the TSI engine, Ultra Low Sulphur Petrol (ULSP) must be used.</p> <p>05) The use of RME and FAME (bio diesel) is not possible.</p> <p>06) Official fuel consumption according to EU Directive 99/94. The consumption calculation according to 1999/100/EC is based on the actual unladen weight of the vehicle. Additional specifications can lead to a higher weight class and hence to consumption figures of this higher weight class. The driving style, road and traffic conditions, environmental influences and vehicle condition can in practice lead to consumption figures, which may differ from those calculated with this standard.</p> <p>07) The weight of a vehicle will influence the level of CO₂ emission it produces; as a result, vehicles with higher levels of specification and factory-fitted options may emit higher levels of CO₂.</p>
	Cubic capacity, ltrs/cc	1.4/1390	1.4/1390	
	Max. output, PS ⁽⁰¹⁾ /kW at rpm	85/63 5000	85/63 5000	
	Max. torque, lbs.ft/Nm at rpm	97/132 3800	97/132 3800	
	Gearbox	Five speed manual	Seven speed auto DSG	
Weights, kgs	Unladen weight ⁽⁰²⁾	1070	1104	
	Gross vehicle weight	1550	1580	
	Payload ⁽⁰²⁾	555	551	
	Axle load limit: Front	830	860	
	Rear	770	770	
Trailer load limits, kgs⁽⁰³⁾	Braked 12% incline	1000	1000	
	Unbraked	530	550	
	Towbar load limit	50	50	
	Max. roof load	75	75	
Performance	Top speed (where the law permits), mph (km/h)	110 (177)	110 (177)	
	Acceleration, secs 0 - 62 mph	11.9	11.9	
	ABI insurance group, 1 - 20 (1 - 50) [†]	4E (9E)	4E (9E)	
Environmental information	Fuel grade, minimum	Unleaded, 95 RON ⁽⁰⁴⁾	Unleaded, 95 RON ⁽⁰⁴⁾	
	Fuel tank capacity, galls/ltrs	10.0/45	10.0/45	
	Official fuel consumption, mpg/ltr per 100 km ⁽⁰⁶⁾			
	Urban	35.3/8.0	36.7/7.7	
	Extra-urban	60.1/4.7	60.1/4.7	
	Combined	47.9/5.9	48.7/5.8	
	Official CO ₂ emission, g/km ⁽⁰⁷⁾	139	135	
	Emission class	EURO 5	EURO 5	
Noise, dB	73.0	73.0		

† Please note, as of December 2009 the insurance industry switched from the current rating system of groups 1 - 20 to a new 1 - 50 insurance scale.

SEL – 1.2 litre TSI 105 PS

Technical specification

		Manual	
Engine	Engine type	Four cylinder petrol	
	Cubic capacity, ltrs/cc	1.2/1197	
	Max. output, PS ⁽⁰¹⁾ /kW at rpm	105/75 5000	
	Max. torque, lbs.ft/Nm at rpm	129/175 1550-4100	
	Gearbox	Six speed manual	
Weights, kgs	Unladen weight ⁽⁰²⁾	1088	
	Gross vehicle weight	1570	
	Payload ⁽⁰²⁾	557	
	Axle load limit: Front Rear	850 770	
Trailer load limits, kgs ⁽⁰³⁾	Braked 12% incline	1200	
	Unbraked	540	
	Towbar load limit	50	
	Max. roof load	75	
Performance	Top speed (where the law permits), mph (km/h)	118 (190)	
	Acceleration, secs 0 - 62 mph	9.7	
	ABI insurance group, 1 - 20 (1 - 50) [†]	5E (13E)	
Environmental information	Fuel grade, minimum	Unleaded, 95 RON ⁽⁰⁴⁾	
	Fuel tank capacity, galls/ltrs	10.0/45	
	Official fuel consumption, mpg/ltr per 100 km ⁽⁰⁶⁾		
	Urban	41.5/6.8	
	Extra-urban	62.8/4.5	
	Combined	53.3/5.3	
	Official CO ₂ emission, g/km ⁽⁰⁷⁾	124	
Emission class	EURO 5		
Noise, dB	71.0		

Notes

- 01) The maximum power output figures are quoted in PS (or Pferdestärke, which is the metric equivalent of horsepower). To convert from metric to imperial horsepower, divide the PS figure by 1.0139.
- 02) Figures are calculated in accordance with manufacturer's criteria. The individual unladen weight depends on the specification of the vehicle, this then reduces the possible payload accordingly. The unladen weight and payload both include the fuel tank 90% full, driver (68 kg) and luggage (7 kg) in line with EU directive 95/48. Unladen weight shown refers to 3-door models. The unladen weight of 5-door models will increase by 25 kg.
- 03) With increasing altitude the engine performance diminishes. From 1,000 m above sea level and for every 1,000 m thereafter 10% of the vehicle/trailer weight (trailer weight + gross vehicle weight) must be deducted.
- 04) Thanks to the knock control, unleaded four star (at least 95 RON) can be used instead of unleaded Super plus. In order to achieve maximum fuel consumption benefits on the TSI engine, Ultra Low Sulphur Petrol (ULSP) must be used.
- 05) The use of RME and FAME (bio diesel) is not possible.
- 06) Official fuel consumption according to EU Directive 99/94. The consumption calculation according to 1999/100/EC is based on the actual unladen weight of the vehicle. Additional specifications can lead to a higher weight class and hence to consumption figures of this higher weight class. The driving style, road and traffic conditions, environmental influences and vehicle condition can in practice lead to consumption figures, which may differ from those calculated with this standard.
- 07) The weight of a vehicle will influence the level of CO₂ emission it produces; as a result, vehicles with higher levels of specification and factory-fitted options may emit higher levels of CO₂.

† Please note, as of December 2009 the insurance industry switched from the current rating system of groups 1 - 20 to a new 1 - 50 insurance scale.

GTI – 1.4 litre TSI 180 PS

Technical specification

		Automatic DSG	
Engine	Engine type	Four cylinder petrol	
	Cubic capacity, ltrs/cc	1.4/1390	
	Max. output, PS ⁽⁰¹⁾ /kW at rpm	180/132 6200	
	Max. torque, lbs.ft/Nm at rpm	184/250 2000-4500	
	Gearbox	Seven speed auto DSG	
Weights, kgs	Unladen weight ⁽⁰²⁾	1269	
	Gross vehicle weight	1680	
	Payload ⁽⁰²⁾	486	
	Axle load limit: Front Rear	930 800	
Trailer load limits, kgs ⁽⁰³⁾	Braked 12% incline	1200	
	Unbraked	630	
	Towbar load limit	50	
	Max. roof load	75	
Performance	Top speed (where the law permits), mph (km/h)	142 (229)	
	Acceleration, secs 0 - 62 mph	6.9	
	ABI insurance group, 1 - 20 (1 - 50) [†]	(30E)	
Environmental information	Fuel grade, minimum	Unleaded, 95 RON ⁽⁰⁴⁾	
	Fuel tank capacity, galls/ltrs		
	Official fuel consumption, mpg/ltr per 100 km ⁽⁰⁶⁾		
	Urban	37.7/7.5	
	Extra-urban	55.4/5.1	
	Combined	47.9/5.9	
	Official CO ₂ emission, g/km ⁽⁰⁷⁾	139	
Emission class	EURO 5		
Noise, dB	73.0		

Notes

- 01) The maximum power output figures are quoted in PS (or Pferdestärke, which is the metric equivalent of horsepower). To convert from metric to imperial horsepower, divide the PS figure by 1.0139.
- 02) Figures are calculated in accordance with manufacturer's criteria. The individual unladen weight depends on the specification of the vehicle, this then reduces the possible payload accordingly. The unladen weight and payload both include the fuel tank 90% full, driver (68 kg) and luggage (7 kg) in line with EU directive 95/48. Unladen weight shown refers to 3-door models. The unladen weight of 5-door models will increase by 25 kg.
- 03) With increasing altitude the engine performance diminishes. From 1,000 m above sea level and for every 1,000 m thereafter 10% of the vehicle/trailer weight (trailer weight + gross vehicle weight) must be deducted.
- 04) Thanks to the knock control, unleaded four star (at least 95 RON) can be used instead of unleaded Super plus. In order to achieve maximum fuel consumption benefits on the TSI engine, Ultra Low Sulphur Petrol (ULSP) must be used.
- 05) The use of RME and FAME (bio diesel) is not possible.
- 06) Official fuel consumption according to EU Directive 99/94. The consumption calculation according to 1999/100/EC is based on the actual unladen weight of the vehicle. Additional specifications can lead to a higher weight class and hence to consumption figures of this higher weight class. The driving style, road and traffic conditions, environmental influences and vehicle condition can in practice lead to consumption figures, which may differ from those calculated with this standard.
- 07) The weight of a vehicle will influence the level of CO₂ emission it produces; as a result, vehicles with higher levels of specification and factory-fitted options may emit higher levels of CO₂.

† Please note, as of December 2009 the insurance industry switched from the current rating system of groups 1 - 20 to a new 1 - 50 insurance scale.

BlueMotion – 1.2 litre TDI 75 PS

Technical specification

		Manual		Notes
Engine	Engine type	Three cylinder diesel		<p>01) The maximum power output figures are quoted in PS (or Pferdestärke, which is the metric equivalent of horsepower). To convert from metric to imperial horsepower, divide the PS figure by 1.0139.</p> <p>02) Figures are calculated in accordance with manufacturer's criteria. The individual unladen weight depends on the specification of the vehicle, this then reduces the possible payload accordingly. The unladen weight and payload both include the fuel tank 90% full, driver (68 kg) and luggage (7 kg) in line with EU directive 95/48. Unladen weight shown refers to 3-door models. The unladen weight of 5-door models will increase by 25 kg.</p> <p>03) With increasing altitude the engine performance diminishes. From 1,000 m above sea level and for every 1,000 m thereafter 10% of the vehicle/trailer weight (trailer weight + gross vehicle weight) must be deducted.</p> <p>04) Thanks to the knock control, unleaded four star (at least 95 RON) can be used instead of unleaded Super plus. In order to achieve maximum fuel consumption benefits on the TSI engine, Ultra Low Sulphur Petrol (ULSP) must be used.</p> <p>05) The use of RME and FAME (bio diesel) is not possible.</p> <p>06) Official fuel consumption according to EU Directive 99/94. The consumption calculation according to 1999/100/EC is based on the actual unladen weight of the vehicle. Additional specifications can lead to a higher weight class and hence to consumption figures of this higher weight class. The driving style, road and traffic conditions, environmental influences and vehicle condition can in practice lead to consumption figures, which may differ from those calculated with this standard.</p> <p>07) The weight of a vehicle will influence the level of CO₂ emission it produces; as a result, vehicles with higher levels of specification and factory-fitted options may emit higher levels of CO₂.</p>
	Cubic capacity, ltrs/cc	1.2/1199		
	Max. output, PS ⁽⁰¹⁾ /kW at rpm	75/55 4200		
	Max. torque, lbs.ft/Nm at rpm	133/180 2000		
	Gearbox	Five speed manual		
Weights, kgs	Unladen weight ⁽⁰²⁾	1150		
	Gross vehicle weight	1590		
	Payload ⁽⁰²⁾	515		
	Axle load limit: Front Rear	900 740		
Trailer load limits, kgs⁽⁰³⁾	Braked 12% incline	800		
	Unbraked	570		
	Towbar load limit	50		
	Max. roof load	75		
Performance	Top speed (where the law permits), mph (km/h)	107 (173)		
	Acceleration, secs 0 - 62 mph	13.9		
	ABI insurance group, 1 - 20 (1 - 50) [†]	(9E)		
Environmental information	Fuel grade, minimum	Diesel ⁽⁰⁵⁾		
	Fuel tank capacity, galls/ltrs	10.0/45		
	Official fuel consumption, mpg/ltr per 100 km ⁽⁰⁶⁾			
	Urban	67.3/4.2		
	Extra-urban	91.1/3.1		
	Combined	80.7/3.5		
	Official CO ₂ emission, g/km ⁽⁰⁷⁾	91		
Emission class	EURO 5			
Noise, dB	69.0			

† Please note, as of December 2009 the insurance industry switched from the current rating system of groups 1 - 20 to a new 1 - 50 insurance scale.

SE – 1.2 litre TDI 75 PS

Technical specification

		Manual		Notes
Engine	Engine type	Three cylinder diesel		<p>01) The maximum power output figures are quoted in PS (or Pferdestärke, which is the metric equivalent of horsepower). To convert from metric to imperial horsepower, divide the PS figure by 1.0139.</p> <p>02) Figures are calculated in accordance with manufacturer's criteria. The individual unladen weight depends on the specification of the vehicle, this then reduces the possible payload accordingly. The unladen weight and payload both include the fuel tank 90% full, driver (68 kg) and luggage (7 kg) in line with EU directive 95/48. Unladen weight shown refers to 3-door models. The unladen weight of 5-door models will increase by 25 kg.</p> <p>03) With increasing altitude the engine performance diminishes. From 1,000 m above sea level and for every 1,000 m thereafter 10% of the vehicle/trailer weight (trailer weight + gross vehicle weight) must be deducted.</p> <p>04) Thanks to the knock control, unleaded four star (at least 95 RON) can be used instead of unleaded Super plus. In order to achieve maximum fuel consumption benefits on the TSI engine, Ultra Low Sulphur Petrol (ULSP) must be used.</p> <p>05) The use of RME and FAME (bio diesel) is not possible.</p> <p>06) Official fuel consumption according to EU Directive 99/94. The consumption calculation according to 1999/100/EC is based on the actual unladen weight of the vehicle. Additional specifications can lead to a higher weight class and hence to consumption figures of this higher weight class. The driving style, road and traffic conditions, environmental influences and vehicle condition can in practice lead to consumption figures, which may differ from those calculated with this standard.</p> <p>07) The weight of a vehicle will influence the level of CO₂ emission it produces; as a result, vehicles with higher levels of specification and factory-fitted options may emit higher levels of CO₂.</p>
	Cubic capacity, ltrs/cc	1.2/1199		
	Max. output, PS ⁽⁰¹⁾ /kW at rpm	75/55 4200		
	Max. torque, lbs.ft./Nm at rpm	133/180 2000		
	Gearbox	Five speed manual		
Weights, kgs	Unladen weight ⁽⁰²⁾	1132		
	Gross vehicle weight	1620		
	Payload ⁽⁰²⁾	563		
	Axle load limit: Front Rear	900 770		
Trailer load limits, kgs⁽⁰³⁾	Braked 12% incline	1000		
	Unbraked	600		
	Towbar load limit	50		
	Max. roof load	75		
Performance	Top speed (where the law permits), mph (km/h)	105 (170)		
	Acceleration, secs 0 - 62 mph	13.9		
	ABI insurance group, 1 - 20 (1 - 50) [†]	TBA		
Environmental information	Fuel grade, minimum	Diesel ⁽⁰⁵⁾		
	Fuel tank capacity, galls/ltrs	10.0/45		
	Official fuel consumption, mpg/ltr per 100 km ⁽⁰⁶⁾			
	Urban	58.9/4.8		
	Extra-urban	83.1/3.4		
	Combined	72.4/3.9		
	Official CO ₂ emission, g/km ⁽⁰⁷⁾	102		
Emission class	EURO 5			
Noise, dB	69.0			

† Please note, as of December 2009 the insurance industry switched from the current rating system of groups 1 - 20 to a new 1 - 50 insurance scale.

SEL – 1.6 litre TDI 90 PS

Technical specification

		Manual		Notes
Engine	Engine type	Four cylinder diesel		<p>01) The maximum power output figures are quoted in PS (or Pferdestärke, which is the metric equivalent of horsepower). To convert from metric to imperial horsepower, divide the PS figure by 1.0139.</p> <p>02) Figures are calculated in accordance with manufacturer's criteria. The individual unladen weight depends on the specification of the vehicle, this then reduces the possible payload accordingly. The unladen weight and payload both include the fuel tank 90% full, driver (68 kg) and luggage (7 kg) in line with EU directive 95/48. Unladen weight shown refers to 3-door models. The unladen weight of 5-door models will increase by 25 kg.</p> <p>03) With increasing altitude the engine performance diminishes. From 1,000 m above sea level and for every 1,000 m thereafter 10% of the vehicle/trailer weight (trailer weight + gross vehicle weight) must be deducted.</p> <p>04) Thanks to the knock control, unleaded four star (at least 95 RON) can be used instead of unleaded Super plus. In order to achieve maximum fuel consumption benefits on the TSI engine, Ultra Low Sulphur Petrol (ULSP) must be used.</p> <p>05) The use of RME and FAME (bio diesel) is not possible.</p> <p>06) Official fuel consumption according to EU Directive 99/94. The consumption calculation according to 1999/100/EC is based on the actual unladen weight of the vehicle. Additional specifications can lead to a higher weight class and hence to consumption figures of this higher weight class. The driving style, road and traffic conditions, environmental influences and vehicle condition can in practice lead to consumption figures, which may differ from those calculated with this standard.</p> <p>07) The weight of a vehicle will influence the level of CO₂ emission it produces; as a result, vehicles with higher levels of specification and factory-fitted options may emit higher levels of CO₂.</p>
	Cubic capacity, ltrs/cc	1.6/1598		
	Max. output, PS ⁽⁰¹⁾ /kW at rpm	90/66 4200		
	Max. torque, lbs.ft/Nm at rpm	170/230 1500-2500		
	Gearbox	Five speed manual		
Weights, kgs	Unladen weight ⁽⁰²⁾	1157		
	Gross vehicle weight	1650		
	Payload ⁽⁰²⁾	568		
	Axle load limit: Front Rear	930 770		
Trailer load limits, kgs⁽⁰³⁾	Braked 12% incline	1200		
	Unbraked	570		
	Towbar load limit	50		
	Max. roof load	75		
Performance	Top speed (where the law permits), mph (km/h)	112 (180)		
	Acceleration, secs 0 - 62 mph	11.5		
	ABI insurance group, 1 - 20 (1 - 50) [†]	4E (13E)		
Environmental information	Fuel grade, minimum	Diesel ⁽⁰⁵⁾		
	Fuel tank capacity, galls/ltrs	10.0/45		
	Official fuel consumption, mpg/ltr per 100 km ⁽⁰⁶⁾			
	Urban	52.3/5.4		
	Extra-urban	78.5/3.6		
	Combined	65.7/4.3		
	Official CO ₂ emission, g/km ⁽⁰⁷⁾	112		
Emission class	EURO 5			
Noise, dB	70.0			

† Please note, as of December 2009 the insurance industry switched from the current rating system of groups 1 - 20 to a new 1 - 50 insurance scale.

Technology

Engines

- Front transverse-installed engine
- 1.2 litre/60 PS ⁽⁰¹⁾ (44 kW) petrol engine: EU5 compliant three cylinder in-line engine, four valves per cylinder. Air filter in wheel housing, chain driven camshaft, split cylinder block, crankshaft drive with balancer shaft, cross-flow cooling in cylinder head, standing oil filter, non-return fuel system, crankcase breather and ventilation system, single spark ignition coils with integrated output stage. Three-way catalytic converters with lambda control
- 1.2 litre/70 PS ⁽⁰¹⁾ (51 kW) petrol engine: EU5 compliant three cylinder in-line engine, four valves per cylinder. Air filter in wheel housing, chain driven camshaft, split cylinder block, crankshaft drive with balancer shaft, cross-flow cooling in cylinder head, standing oil filter, non-return fuel system, crankcase breather and ventilation system, single spark ignition coils with integrated output stage. Three-way catalytic converters with lambda control
- 1.4 litre/85 PS ⁽⁰¹⁾ (63 kW) petrol engine: EU5 compliant four cylinder in-line engine, four valves per cylinder. Toothed belt pulley on crankshaft with elliptic shape to reduce toothed belt vibrations, coated toothed belt, intake pipe with modular design, crankcase breather and ventilation system with diaphragm valve to regulate pressure in cylinder block, pre-warming for crankcase ventilation integrated in cooling system. Starter and main catalytic converter with lambda control
- 1.2 litre/105 PS ⁽⁰¹⁾ (75 kW) petrol engine: TBA
- 1.4 litre/180 PS ⁽⁰¹⁾ (132 kW) petrol engine: TBA
- 1.2 litre/75 PS ⁽⁰¹⁾ (55 kW) common rail diesel engine: TBA
- 1.6 litre/90 PS ⁽⁰¹⁾ (66 kW) common rail diesel engine: EU5 emissions standard, four cylinder in-line engine, four valves per cylinder, aluminium-silicon alloy cylinder head, reduced piston crown volume (improves swirl generation in the cylinder), toothed backlash compensator, intake manifold with electric continual tumble flap control, electronically controlled common rail direct injection fuel system with Bosch high pressure pump (up to 1800 bar) and 8-hole piezo injector units, pre-supply electronic fuel pump, oil cooler, intercooler, low temperature exhaust gas recirculation, additional coolant pump, turbocharger with variable turbine geometry, catalytic converter and Diesel Particulate Filter (DPF)

Transmission

- Front wheel drive through asbestos-free single-plate dry clutch. Hydraulic clutch-mechanism. Six speed manual or seven speed automatic DSG gearbox with double joint half axles
- Five speed manual: 1.2 litre 60 PS, 1.2 litre 70 PS, 1.4 litre 85 PS, 1.2 litre TDI 75 PS, 1.6 litre TDI 90 PS
- Six speed manual: 1.2 litre TSI 105 PS
- Seven speed automatic DSG: 1.4 litre 85 PS, 1.4 litre TSI 180 PS

Running gear

- Electronic Stabilisation Programme (ESP) including Electronic Differential Lock (EDL), Traction Control (ASR) and Countersteer Support
- XDS electronic differential lock (GTI only)
- Front suspension through coil springs with telescopic shock absorbers, all elements integrated in chassis legs
- Rear suspension with gas pressure shock absorbers and separate springs
- Wheel control: front through chassis legs and (lower) triangular wishbones (directionally stabilising steering roll radius)
- Wheel control: rear through four-link suspension with independent wheel suspension
- Front and rear anti-roll bar

Steering

- Electro-mechanical steering rack
- Collapsible, height and lengthways adjustable safety steering column

Brakes

- Electronically controlled Anti-lock Braking System (ABS) with Electronic Brake-pressure Distribution (EBD)
- Diagonal twin-circuit brake system with front and rear disc brakes (front ventilated)
- Rear drum brakes (1.2 litre 60 PS, 1.2 litre 70 PS, 1.4 litre 85 PS and 1.2 litre TDI 75 PS)
- Asbestos-free brake pads
- Hydraulic Brake Assist (HBA)

Dimensions

Exterior dimensions	S, BlueMotion, Moda, SE, SEL		GTI
	Length, mm	3970	3976
Width – including door mirrors, mm	1901	1901	
Width – excluding door mirrors, mm	1682	1682	
Width – opened front doors – 3 door, mm	3933	3933	
Width – opened front/rear doors – 5 door, mm	3456/3207	3456/3207	
Height, mm	1462 (1465)	1452	
Height – opened bonnet/floor, mm	1753 (1756)	1744	
Height – opened tailgate/floor, mm	2000 (2003)	1990	
Wheelbase, mm	2470 (2468)	2468	
Turning circle, m	10.6	10.6	

Interior dimensions	S, BlueMotion, Moda, SE, SEL		GTI
	Effective headroom – front, mm	974	974
Effective headroom – rear, mm	943	943	

() BlueMotion figures.

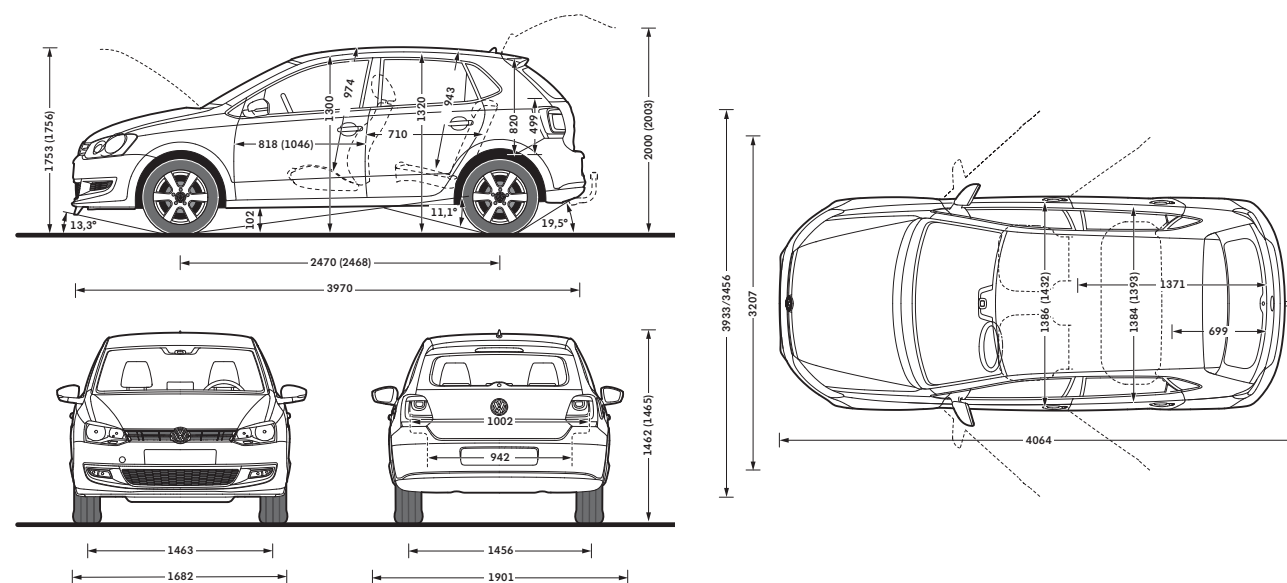

Volkswagen service

The Volkswagen Warranty.

Three-year Warranty.

All Volkswagen Polos come with a three-year/60,000 miles warranty, which protects your car against the failure of most mechanical and electrical components due to manufacturing defects. This comprises a two-year manufacturer's warranty with unlimited mileage plus a further one-year/60,000 miles (whichever is soonest) Retailer Warranty. Should the mileage exceed 60,000 miles within the first two years, the manufacturer's two-year warranty will still be valid. If an additional warranty for subsequent years or higher mileage is desired, it may be purchased from an authorised Volkswagen retailer or repairer; however, this additional warranty must be purchased before the mileage reaches 60,000*. Full details of the three-year warranty are available from your authorised Volkswagen retailer or repairer.

* All warranty work must be completed by an authorised Volkswagen retailer or repairer.

Three-year Paint Warranty.

The paintwork of the Polo is covered against manufacturing defects for a period of three years. Naturally, the Polo must be cared for in compliance with the operating instructions which will be found in your vehicle handbook. Please consult your authorised Volkswagen retailer or repairer for full warranty details.

12-year Body Protection Warranty.

The internal body sections and panels of the Polo are covered against rusting through from the inside for 12 years. Naturally, Polo must be cared for in compliance with the operating instructions. Please consult your authorised Volkswagen retailer or repairer for full warranty details.

Approved Accessories.

A comprehensive range of accessories from alloy wheels to carpet mats is available to complement the factory-fitted option list. Volkswagen approved accessories purchased from and fitted by your authorised Volkswagen retailer at the point of vehicle sale will also benefit from the three-year vehicle warranty.

Service Intervals.

Volkswagen are pleased to offer you a choice on how your Polo is serviced. The appropriate selection is entirely dependent on how the car is likely to be driven and its general use. To help you identify which type of service would be most suitable, please refer to the following guide.

The Time and Distance Service is recommended for vehicles that will cover less than 10,000 miles in 12 months and if the vehicle is likely to be used in the following way:

- Predominantly urban driving, short journeys with frequent cold starts.
- Activities regularly producing high engine loading, e.g. frequent hill climbs, driving with vehicle fully loaded and towing.
- Uneconomical driving style using high rpms with heavy acceleration and heavy braking.

The service intervals for the Time and Distance Service are as follows:

- Oil change service
Every 10,000 miles/1 year (whichever is soonest).
- Interval service
Every 20,000 miles/2 years (whichever is soonest).
- Inspection service
Every 40,000 miles/3 years (whichever is soonest).

The LongLife Service is recommended for vehicles with a daily mileage of more than 25 miles where the vehicle is driven regularly mainly on longer distance journeys. The vehicle is driven mainly at a constant speed with minimum vehicle and engine loading, minimal towing and driven in an economical manner.

With the LongLife Service the vehicle can cover anywhere between 10,000[†] and a maximum of 18,000[†] miles or 24 months (whichever is soonest) between oil changes. Inspection service is typically in the third year of ownership and thereafter every second year, for vehicles with an approximate annual mileage of 10,000 miles.

[†] Please note that mileages are approximate as the service indicator system uses kilometres as the distance measurement. Please consult your authorised Volkswagen retailer or repairer for advice and full details.

Extended Warranty.

You may purchase additional protection from your authorised Volkswagen retailer or repairer, or contact 0870 9000 115

Volkswagen Insurance[‡].

We want you to start enjoying your new car from day one and thanks to Volkswagen Insurance complimentary seven day cover, you can. Call free on 0800 316 7892 (lines are open Monday to Friday 8 am - 9 pm and Saturday 9 am - 5 pm), provide a few details and a cover note will be sent to your retailer. They will then tax your car and you can drive it away.

Visit www.insurewithvolkswagen.co.uk for details of the full range of insurance products available. Here you can also get a quote for your annual car insurance and buy it online too. All of our insurance products are designed to ease the pain of making a claim.

[‡] Volkswagen Insurance is a trading name of Volkswagen Insurance Service (Great Britain) Limited, an appointed representative of Volkswagen Financial Services (UK) Limited, Brunswick Court, Yeomans Drive, Blakelands, Milton Keynes MK14 5LR. Registered in England number 2835230. Volkswagen Insurance is sold, underwritten and administered by Allianz Insurance plc registered in England number 84638. Registered office 57 Ladymead, Guildford, Surrey GU1 1DB. Volkswagen Financial Services (UK) Limited and Allianz Insurance plc are authorised and regulated by the Financial Services Authority. Volkswagen Financial Services (UK) Limited and Allianz Insurance plc are not part of the same corporate group.

Volkswagen Finance[±].

Volkswagen Finance specialises in providing funding solutions for Volkswagen drivers. Whether your Volkswagen is for private or business use, you can choose from a range of funding options.

- Solutions – a personal contract plan
- Hire purchase
- Lease purchase
- Finance lease
- Contract hire

With all Volkswagen Finance products you can choose a fixed-cost maintenance plan to help you budget for your servicing and maintenance costs.

No matter what finance product you choose, your local Volkswagen retailer will be able to provide you with a personalised quote that could meet your budget and vehicle needs.

[±] Volkswagen Finance is a trading name of Volkswagen Financial Services (UK) Limited. An offer of finance depends on certain conditions. Available to people over 18 in the UK only.

Volkswagen Roadside Assistance.

Every new car is registered for Volkswagen Roadside Assistance for one year. This provides vehicle home and roadside recovery in the unlikely event of a breakdown in the UK and Europe (subject to conditions). Volkswagen Roadside Assistance can also be purchased for subsequent years. For full details, please contact your authorised Volkswagen retailer or repairer.

Tax Free Sales.

For full details, please contact your authorised Volkswagen retailer.

CO₂ Emissions.

Increased weight of a vehicle, including higher trim levels and the addition of options will have a detrimental influence on the level of fuel consumption and CO₂ emissions produced.

The CO₂ and fuel consumption figures are obtained from tests on a representative vehicle of the type, conducted and approved in accordance with Council Directive 80/1268/EEC as amended by Directive 1999/100/EC (or later) on the approximation of the laws of the member states relating to the carbon dioxide emissions and the fuel consumption of motor vehicles.

Please Note:

Some illustrations in this brochure do not necessarily reflect UK specifications and may not be available. In particular, controls and some items of equipment are positioned differently for the UK.

The specifications contained in this brochure are for information purposes only and are subject to change. If you require any specific feature, you must consult your authorised Volkswagen retailer who is regularly updated with any change in specification. Please check model availability and full specification details with your authorised Volkswagen retailer prior to ordering.

Note: We would like to advise you that telephone calls to Volkswagen Customer Care may be monitored and recorded as part of our training and quality assurance processes. All our monitoring and recording processes meet Ofcom regulations.